

	11	12	13
	2420	2640	2860
	-	-	-
	2618	2856	3094
140	295°	321°	347°

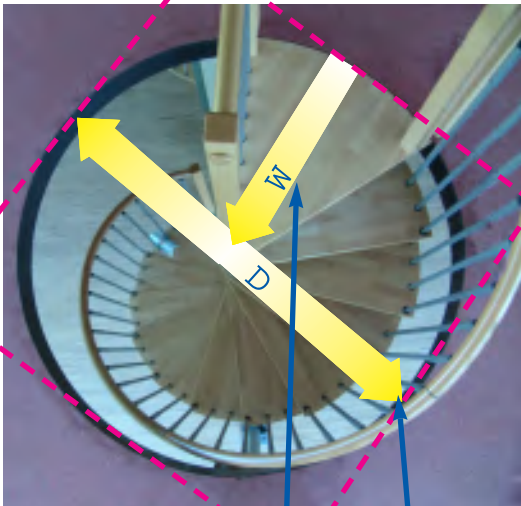

	W	D
140	700-750 mm	>1400 mm

- 3094 mm



- 220-238mm

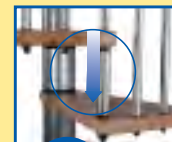

- 200 kg



S1

1 x - 932162



S2

12 x - 932157



S3

910x50x1mm

1 x - 933129



S4

ø60,2 x 1050 mm

1 x - 920924



S5

1 x - 931881



S6

1 x - 920915

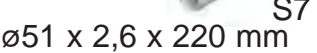

S7

ø51 x 2,6 x 220 mm

1 x - 931886

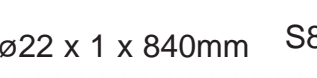

S8

ø22 x 1 x 840mm

22 x - 932118

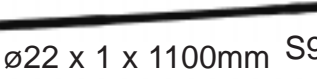

S9

ø22 x 1 x 1100mm

24 x - 932119

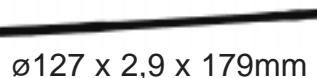

S10

ø127 x 2,9 x 179mm

13 x - 931889



S11

ø22x1x175 mm

15 x - 932159

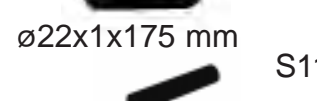

S12

ø22 x 70 mm

1 x - 932159

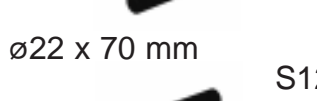

S13

ø50 x 1 x 400 mm

12 x - 932129

910 x 50 x 1 mm S14



1 x - 933129

90 x 90 x 80 x 3 mm



S15

2 x - 931884

ø100 x 3 d21mm



S16

1 x - 931883

M20x1210 mm S17



1 x 930707

M20x900 mm S18



1 x - 930654

M8x1000 mm S19



6 x - 930706

M10x120 mm S20



14 x - 933130



M20x60mm
DIN 6334

S21

1 x - 932143

ø127 x 3 mm



S22

104 x - 930698



S23

3 x - 930623



S24

45 x - 931217

ø50 mm



S25

17 x - 932137



S26

45 x - 932031

ø8 mm		S27	10 x - 930303	M10 x 100 mm		S39	1 x - 930882
ø12 mm		S27	1 x - 930687	M8 x 70 mm DIN 933		S40	3 x - 931735
ø22 mm		S28	1 x - 930631	M8 x 55 mm DIN 6912		S41	6 x - 931879
ø35 mm		S29	5 x - 932138	M5 x 20 mm DIN 7991		S42	45x - 932139
M20 DIN 934		S30	2 x - 930629	M6 x 6 mm DIN 914		S43	6 x - 932141
M8 DIN 934		S31	11 x - 930233	ø6 x 50 mm		S44	10 x - 932152
M5 DIN 934		S32	45x - 930231	ø6 x 30 mm		S45	10 x - 932153
M8 DIN 6334		S33	4 x - 930679	ø3,9 x 19 mm		S46	90 x - 932140
M6 DIN 562		S34	6 x - 932142	ø30 mm (M10 DIN 9021A) x 3 mm		S47	140 x - 933131
M8 x 55 mm		S35	3 x - 931733	ø16 mm (M8 DIN 125A)		S48	3 x - 930680
M10 x 70 mm DIN 6912		S36	45 x 933039			S49	8 x - 933025
M10		S37	74 x 933128	M8 x 14 mm		S50	1 x - 930236
		S38	74 x - 933127				

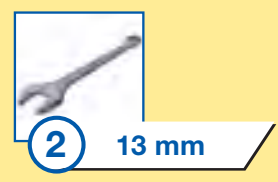
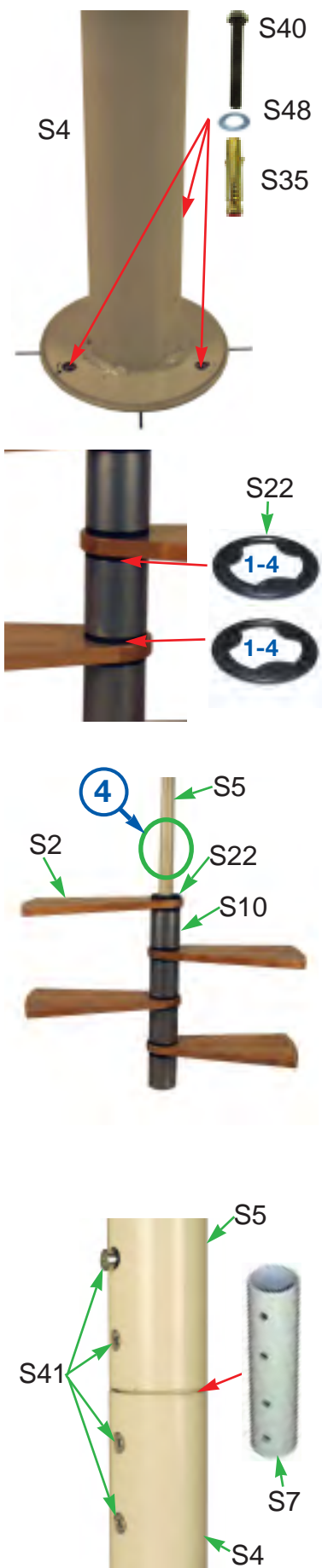

- 2 x S22 = 220 mm
- 3 x S22 = 223 mm
- 4 x S22 = 226 mm
- 5 x S22 = 229 mm
- 6 x S22 = 232 mm
- 7 x S22 = 235 mm
- 8 x S22 = 238 mm

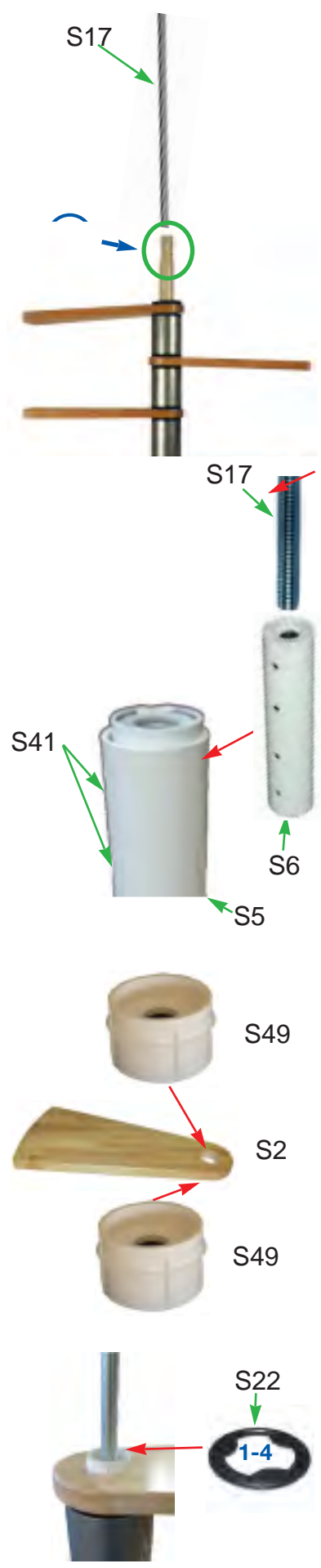
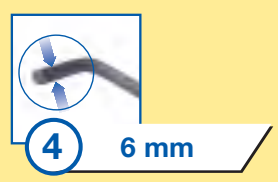

6



S1

7

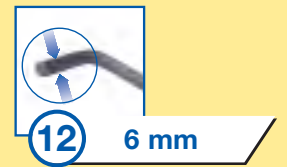
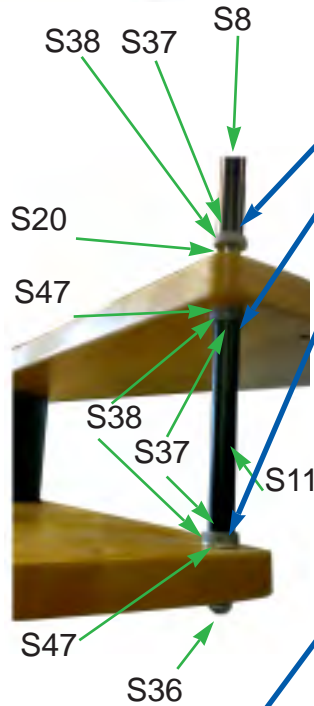
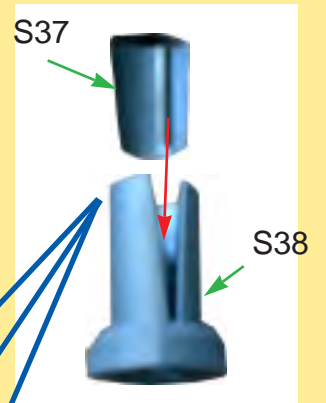
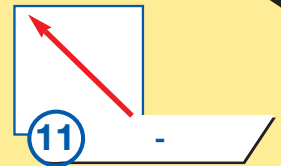
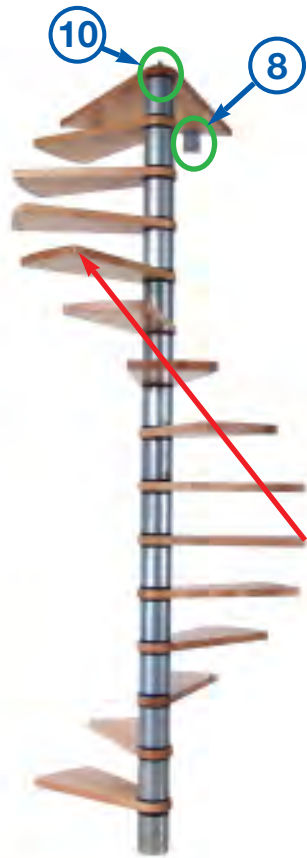
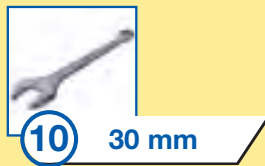
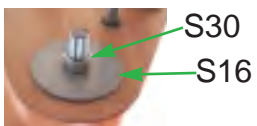
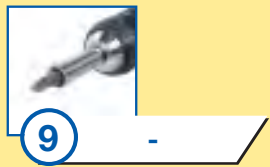
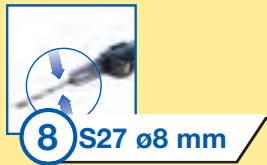
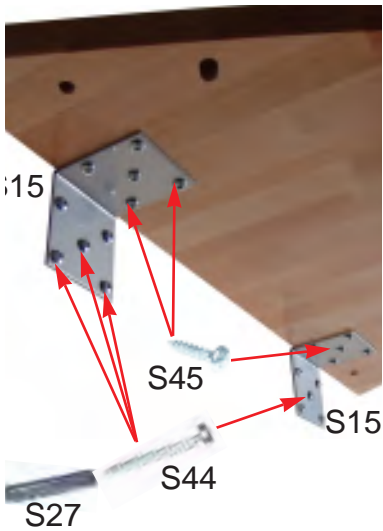

13 196-214 mm

- 0 x S47 = 220 mm
- 1 x S47 = 223 mm
- 2 x S47 = 226 mm
- 3 x S47 = 229 mm
- 4 x S47 = 232 mm
- 5 x S47 = 235 mm
- 6 x S47 = 238 mm



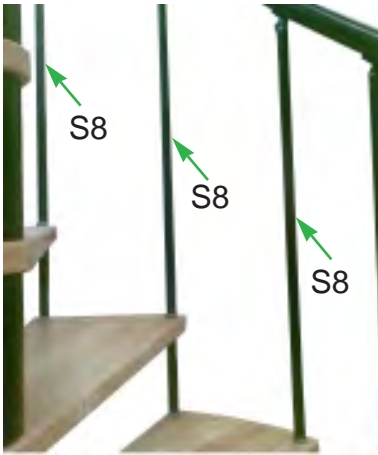

14

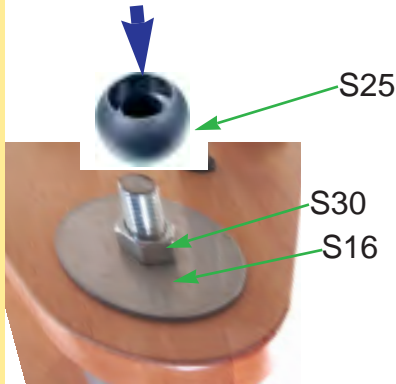
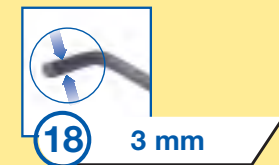
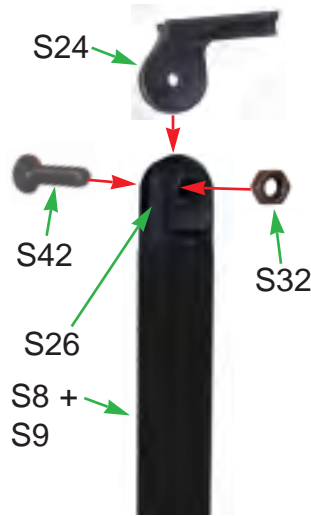
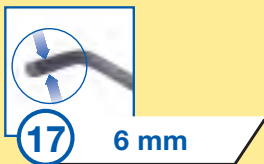
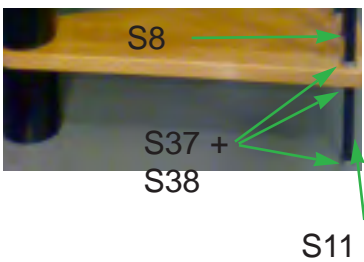
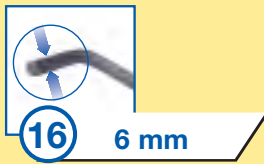
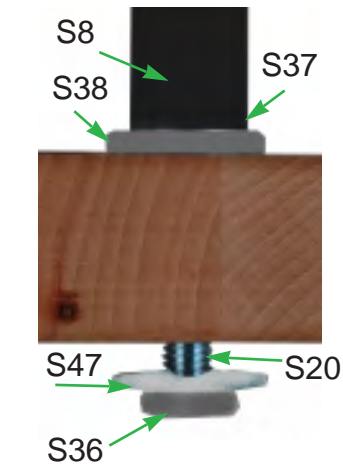
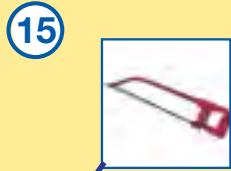

19

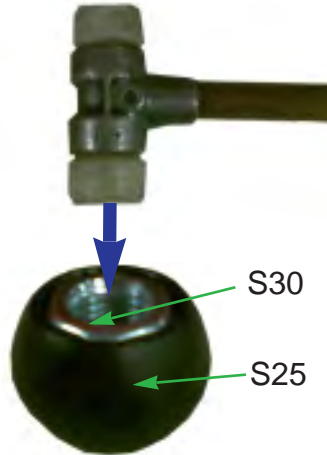

20



21

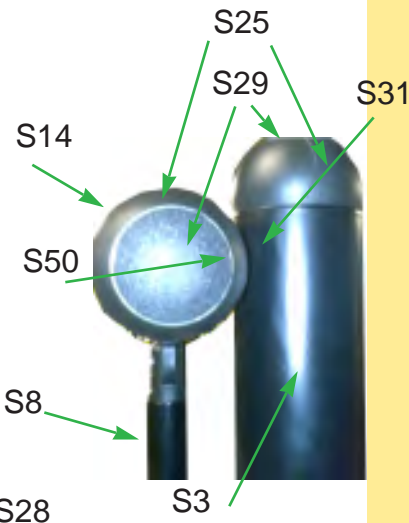

22 13 mm

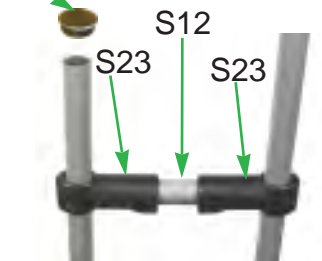

23 3 mm

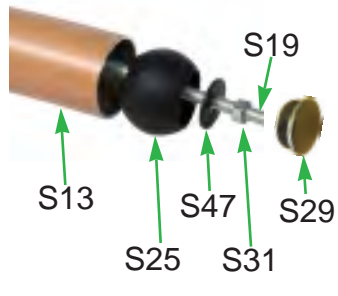

24 13 mm

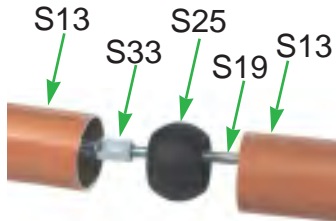

25

